

WYMIARY

Pompa ciepła HT AIR 8 - 13 kW

Przód

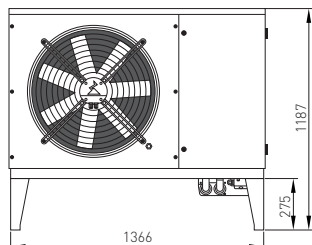

Lewa

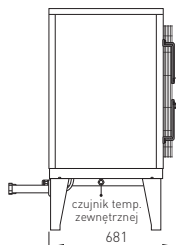

Prawa

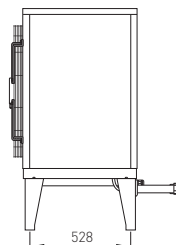

Tył

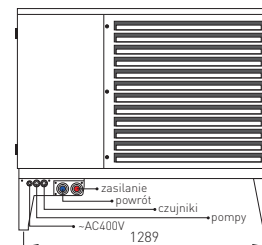

Pompa ciepła HT AIR 16 - 20 kW

Przód

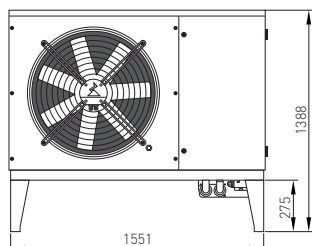

Lewa

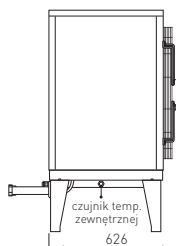

Prawa

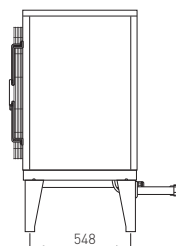

Tył

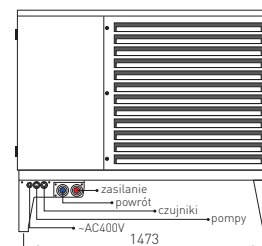

Pompa ciepła HT AIR 25 - 30 kW

Przód

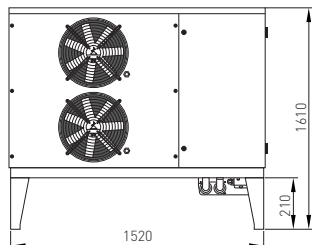

Lewa

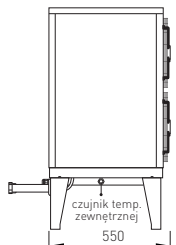

Prawa

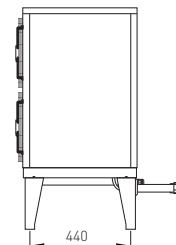

Tył

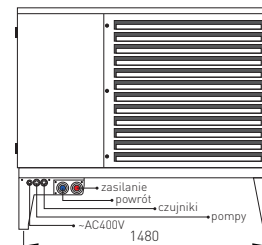

Pompa ciepła HT AIR INV 2-9 · 4-13 kW

Przód

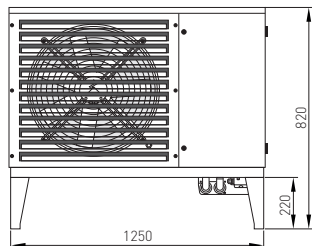

Lewa

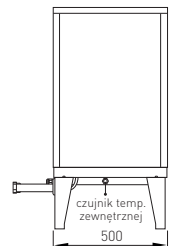

Prawa

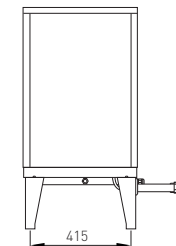

Tył

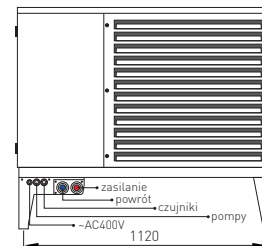

Minimalne odległości od przegród

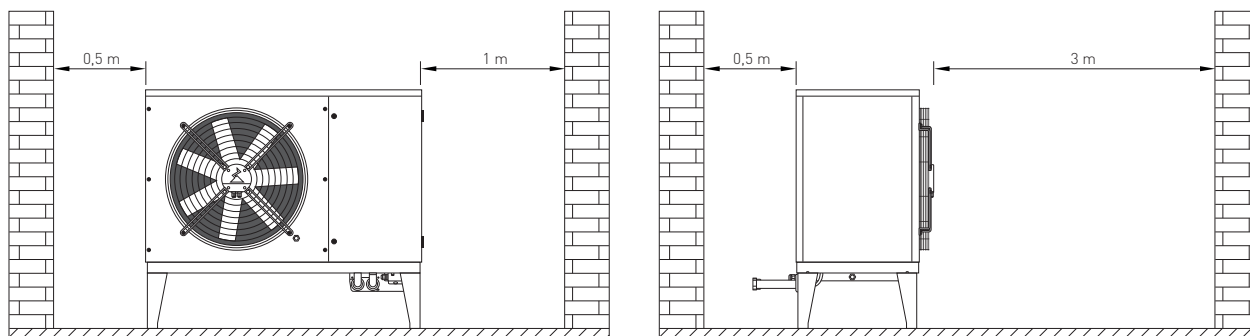

WYMIARY



Pompa ciepła HT AIR 40 - 50 kW

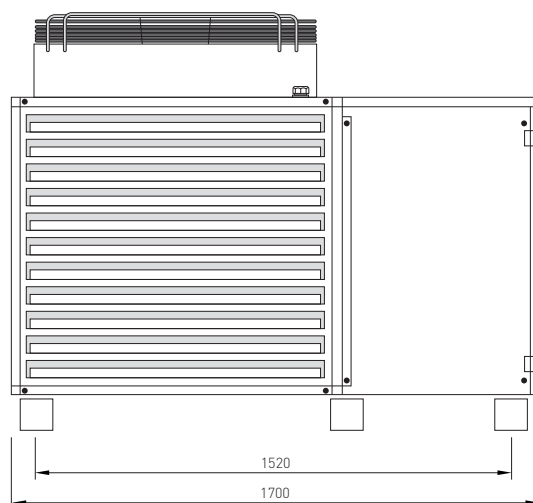
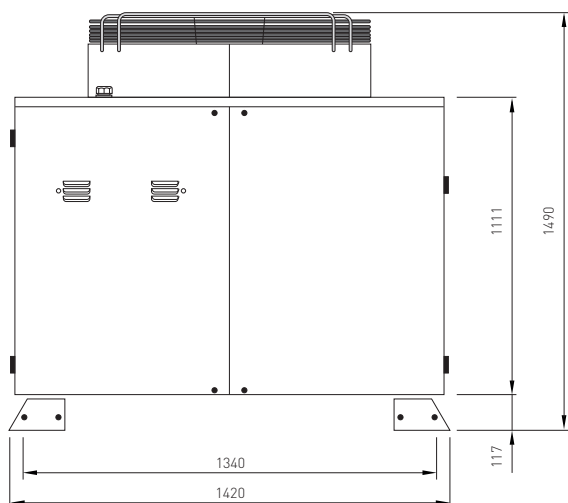

Pompa ciepła HT AIR 60 - 70 kW

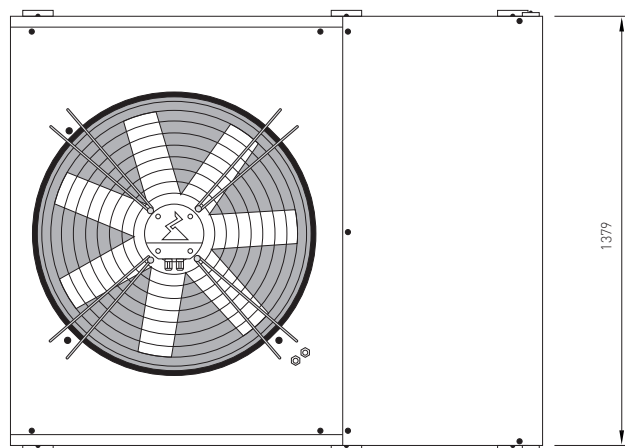
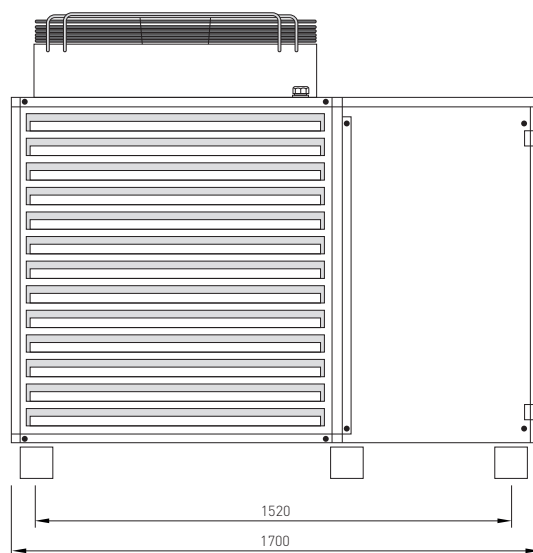
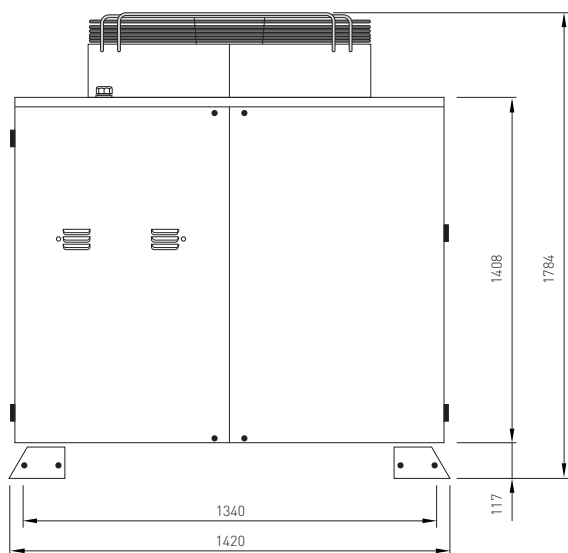

Rzut górny

WYMIARY

